

Technical Data Sheet

Series: **Kyro**

Article code: **86CR8110 02**

Description:

One hole basin mixer, 1"1/4 pop up waste, flex cm 35 x 1/2"F.

Materials:

Brass

Surface finish Chrome:

14 micron Nickel

0.3 microm Chrome

Finishings



CR



Features



Cartridge diam. 35 mm with 2 ceramic disks, with 25° opening angle, and 90° mixing angle. We use only certified white lubricant into our mixers and cartridges.



Aerator Male thread 24 x 1
Flow rate 7 l/min at 3 bar



Stainless steel flex hoses cm 35 with 1/2 brass nut with internal non removable rubber



Metal 1"1/4 pop up waste



Easy installation with 65 mm brass long fixing screw
Suitable for electrical water heater

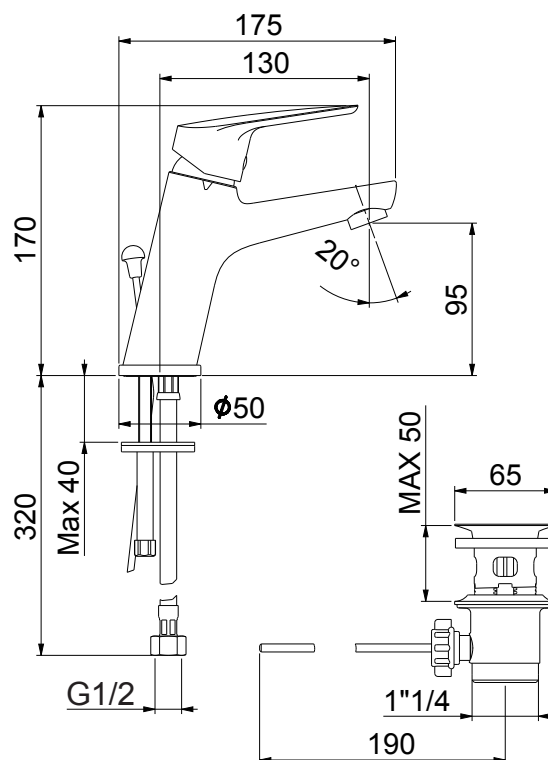

Technical Data Sheet

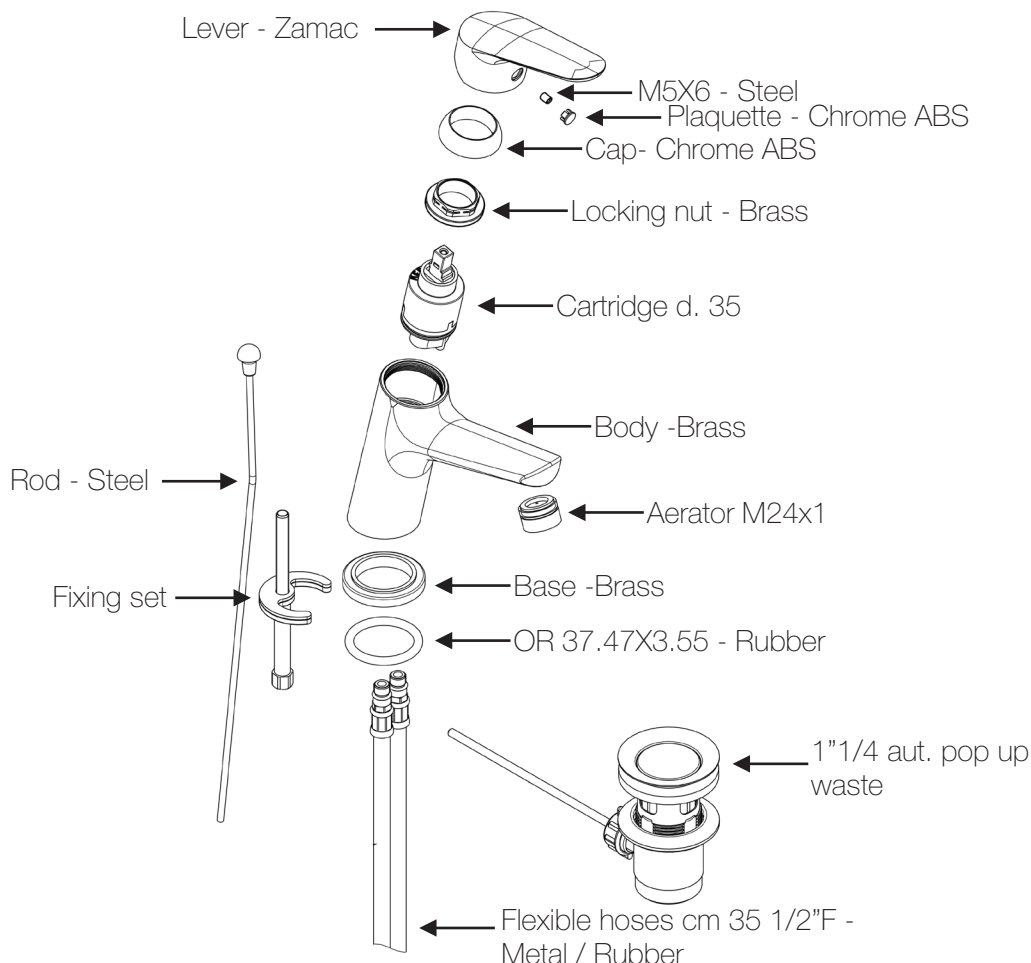

Maintenance

Product care also includes regularly cleaning the aerator filter from impurities and/or lime scale. For correct decalcification, disassemble the aerator and place it into diluted vinegar (max concentration: 10% at 20°C) to remove lime scale deposits and/or dirt from the aerator filters. Leave it to soak for a few hours, and then rinse using only water.

Cleaning recommendation for products and care of finish

Chrome: the chrome surfaces can be cleaned with a mild detergent or with neutral soap and water.

Color finishes: taps with colored finishes should be cleaned only with a cloth and water.

Never use detergents containing mineral acids (ex. hydrochloric acid), aggressive acids (ex. acetic acid), bases (ex. ammonia) phosphoric acid or other aggressive substances, as they can cause significant damage.



www.fiore.it/catalogues